

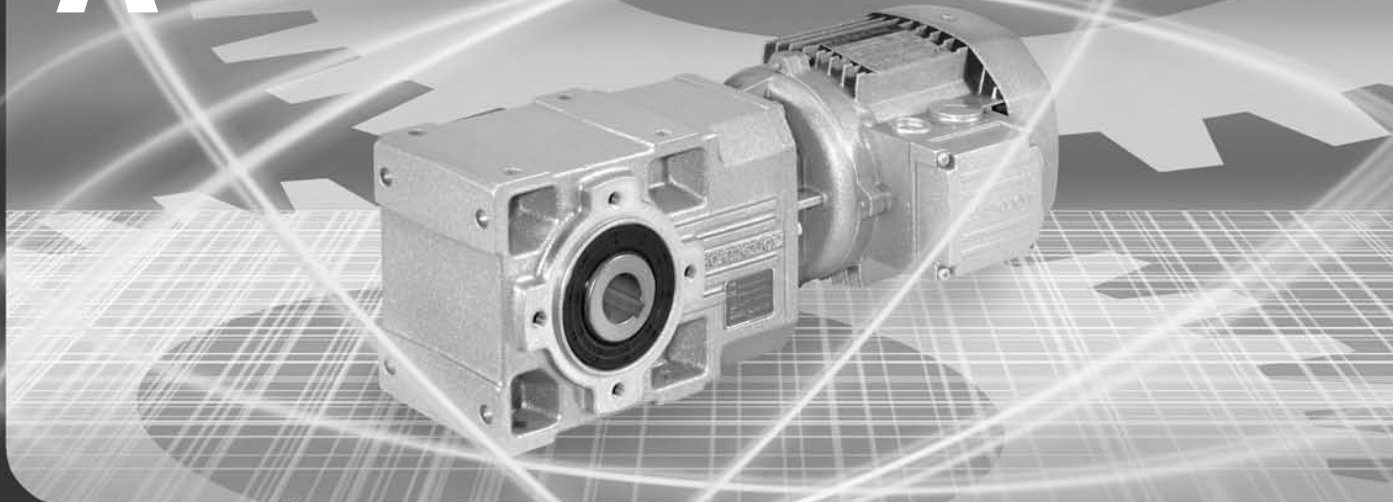











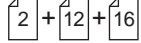

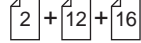

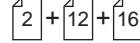

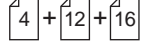



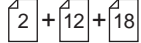

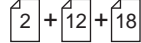

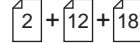

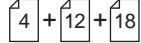













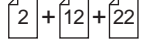

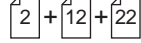

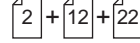

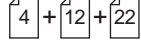





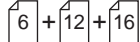

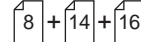

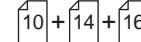

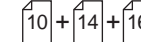



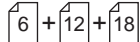

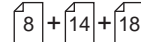

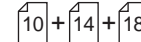

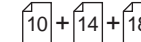









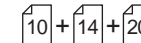

Lista parti di ricambio - Spare parts list - Ersatzteilliste
Liste des pieces detachees - Lista de partes de recambio

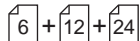
A**BONFIGLIOLI**

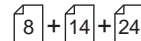
Quadro d'unione delle tavole parti di ricambio
Index of spare parts tables
Inhaltsverzeichnis Ersatzteillisten
Index des tables de pièces de rechange
Índice de la tabla de partes de recambio

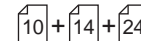
| INPUT | A 10 2 | A 20 2 | A 20 3 | A 30 2 | A 30 3 | A 41 2 | A 41 3 | A 50 2 | A 50 3 | A 50 4 |
|---|---|---|---|--|---|---|---|---|---|---|
|  S_ |  |  |  |  |  |  |  |  |  |  |
|  P63 ... P132 |  |  |  |  |  |  |  |  |  |  |
|  P160 ... P250 |  |  |  |  |  |  |  |  |  |  |
|  HS |  |  |  |  |  |  |  |  |  |  |

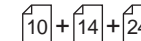
| INPUT | A 60 2 | A 60 3 | A 60 4 | A 70 3 | A 70 4 | A 80 3 | A 80 4 | A 90 3 | A 90 4 |
|---|---|---|---|--|---|---|---|---|---|
|  S_ |  |  |  |  |  |  |  |  |  |
|  P63 ... P132 |  |  |  |  |  |  |  |  |  |
|  P160 ... P250 |  |  |  |  |  |  |  |  |  |
|  HS |  |  |  |  |  |  |  |  |  |

A 10

A 20







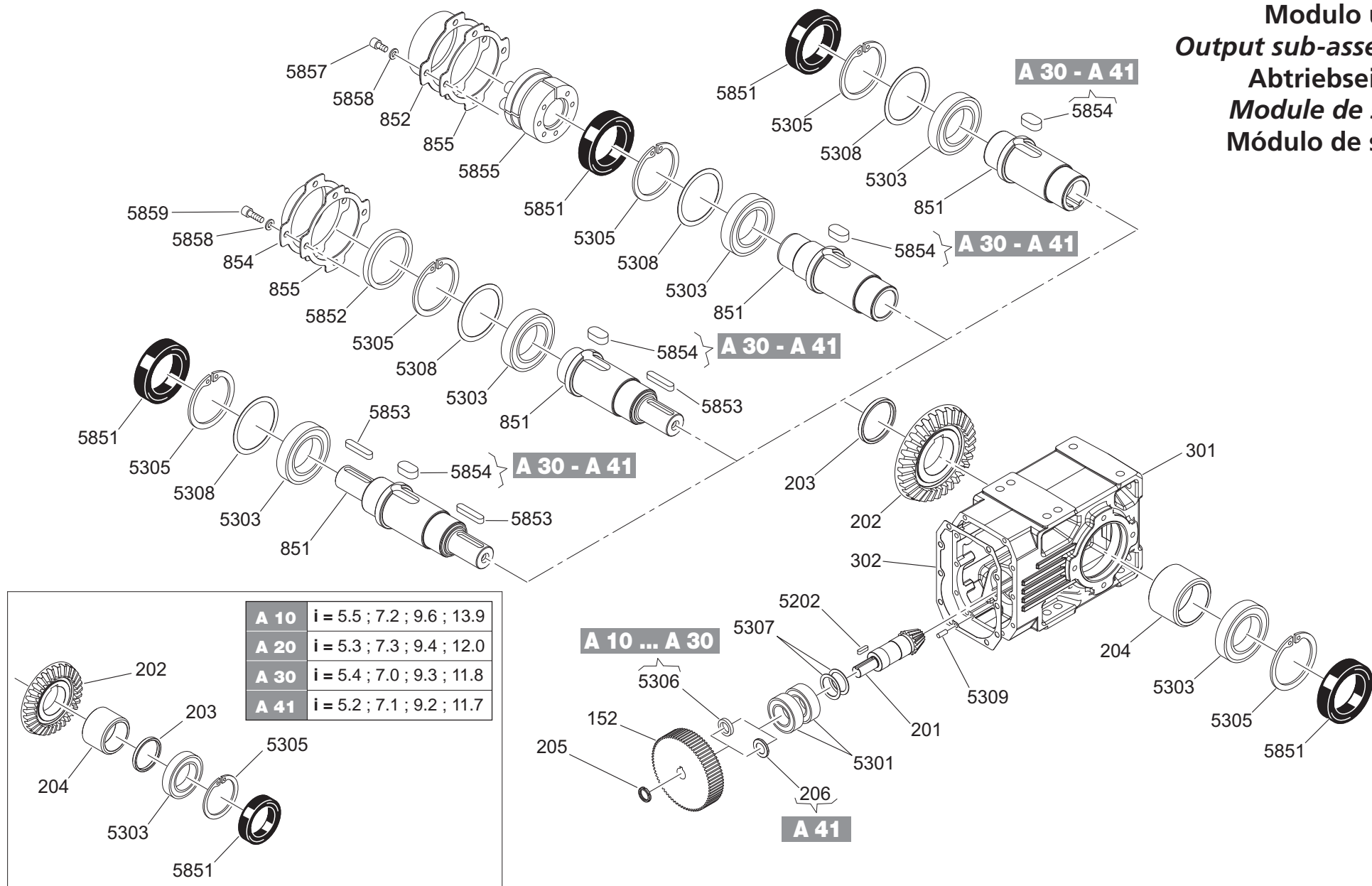

A 30





A 41

Modulo uscita
Output sub-assembly
Abtriebseinheit
Module de sortie
Módulo de salida

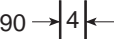

| Pos. | Descrizione | Description | Benennung | Description | Descripción |
|------|--------------|--------------|-------------------|-----------------|---------------|
| 152 | Corona | Housing | Gehäuse | Carter | Caja |
| 201 | Pignone | Pinion gear | Ritzel | Pignon | Piñon |
| 202 | Corona | Gear | Zahnrad | Couronne | Corona |
| 203 | Distanziale | Spacer ring | Distanzring | Entretoise | Distanciador |
| 204 | Distanziale | Spacer ring | Distanzring | Entretoise | Distanciador |
| 206 | Distanziale | Spacer ring | Distanzring | Entretoise | Distanciador |
| 301 | Cassa | Housing | Gehäuse | Carter | Caja |
| 302 | Guarnizione | Gasket | Dichtung | Joint plat | Junta |
| 851 | Albero lento | Output shaft | Abtriebswelle | Arbre de sortie | Eje de salida |
| 852 | Protezione | Safety cover | Schutzvorrichtung | Protection | Protección |
| 854 | Coperchio | Cover | Deckel | Couvercle | Tapa |
| 855 | Guarnizione | Gasket | Dichtung | Joint plat | Junta |







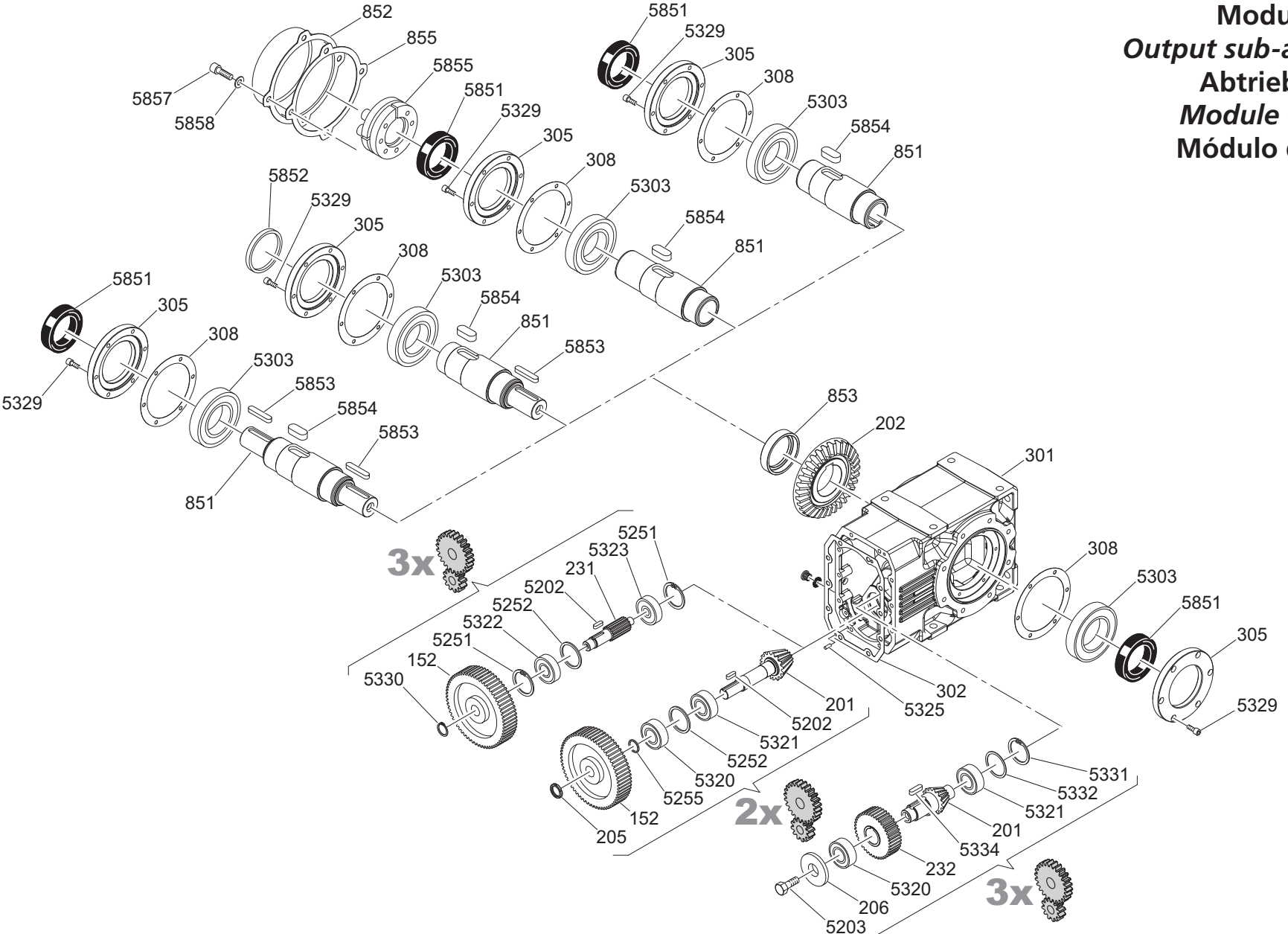



| |  |  |  |  |  |  |  |  |
|------|---|---|--|---|---|---|---|---|
| | 5301 | 5303 | 5305 | 5306 | 5307 | 5308 | 5309 | 5851 |
| A 10 | 32004X | 6009 | 75 | 12.2x16.8x0.5 | 20.2x25.8x0.5 | 66.2x72.8x1 | 5x16 | 45x75x8 DL |
| A 20 | 32005X | 6010 | 80 | 15.2x24.9x0.5 | 25.2x34.8x1 | 68.3x78.8x1 | 5x16 | 50x80x8 DL |
| A 30 | 32006X | 6011 | 90  | 17.2x27.8x0.5 | 30.2x39.8x1 | 75.3x89.8x1 | 6x16 | 55x90x8 DL |
| A 41 | 32007X | 6213 | 120 | - | 35.3x48x1 | 100x120x1 R | 6x16 | 65x120x13 DL |











| |  |  |  |  |  |  |  | |
|------|--|--|--|--|--|--|--|-------------|
| | 5202 | 5853 | 5854 | 5855 | 5857 | 5859 | 5858 | 205 |
| A 10 | 4x4x16 C | 8x7x35 A | - | TLK600.03 ø36 | M8x16 | M8x25 | ø8.4 | M12x1.5 GUA |
| A 20 | 5x5x17 C | 8x7x50 A | - | TLK600.03 ø44 | M8x16 | M8x25 | ø8.4 | M14x1.5 GUA |
| A 30 | 5x5x19 C | 10x8x50 A | 18x11x33 C i = 7 18x11x50 A i = 3 | TLK600.03 ø50 | M8x16 | M8x25 | ø8.4 | M17x1 |
| A 41 | 6x6x25 C | 14x9x70 A | 20x12x40 C i = 7 20x12x60 A i = 3 | TLK600.03 ø55 | M12x20 | M12x30 | ø13 | M20x1.5 |

Modulo uscita
Output sub-assembly
Abtriebseinheit
Module de sortie
Módulo de salida

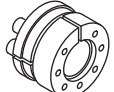

| Pos. | Descrizione | Description | Benennung | Description | Descripción |
|------|--------------------|--------------|-------------------|-----------------|-------------------|
| 152 | Corona | Gear | Zahnrad | Couronne | Corona |
| 201 | Pignone | Pinion gear | Ritzel | Pignon | Piñon |
| 202 | Corona | Gear | Zahnrad | Couronne | Corona |
| 205 | Ghiera | Ring nut | Wellenmutter | Frette | Tuerca del anillo |
| 206 | Rondella | Washer | Unterlegscheibe | Rondelle | Arandela |
| 231 | Pignone | Pinion gear | Ritzel | Pignon | Piñon |
| 232 | Corona | Gear | Zahnrad | Couronne | Corona |
| 301 | Cassa | Housing | Gehäuse | Carter | Caja |
| 302 | Guarnizione cassa | Gasket | Dichtung | Joint plat | Junta |
| 305 | Cappellotto albero | Shaft holder | Deckel | Capuchon | Sombbrero |
| 308 | Guarnizione | Gasket | Dichtung | Joint plat | Junta |
| 851 | Albero lento | Output shaft | Abtriebswelle | Arbre de sortie | Eje de salida |
| 852 | Protezione | Safety cover | Schutzvorrichtung | Protection | Protección |
| 853 | Distanziale | Spacer ring | Distanzring | Entretoise | Distanciador |
| 855 | Guarnizione | Gasket | Dichtung | Joint plat | Junta |





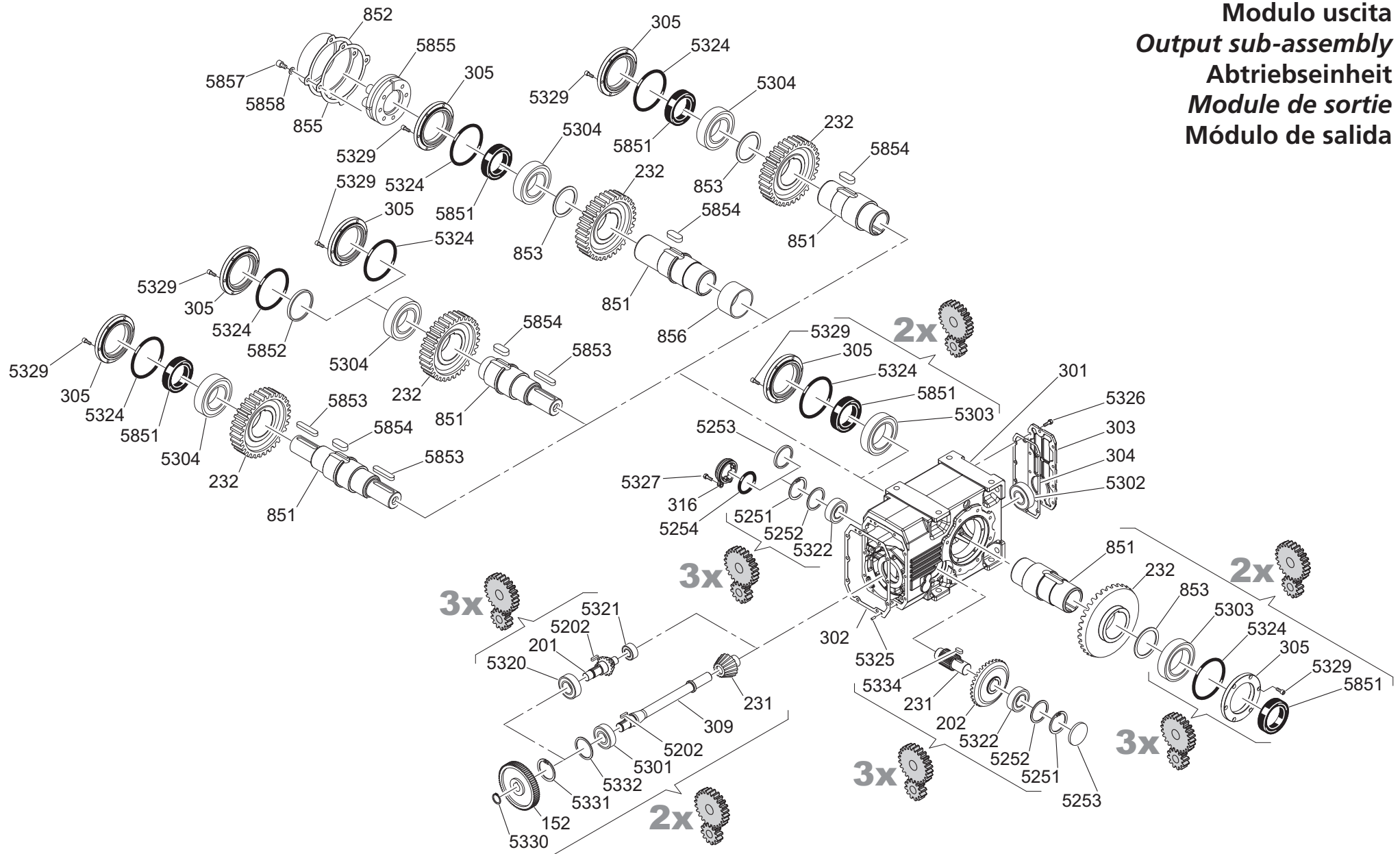

| |  |  |  |  |  |  |  |  |  |  |  |
|---------------|---|---|--|---|---|---|---|---|---|---|--|
| A 50 2 | 6215 6215 2RS | 32206 B | 32206 B | | | | | | 52x62x3 | 25x30x2.5 | |
| A 50 3 | 6215 6215 2RS | 32206 | 32206 | 6305 | 6403 | 62K | 62K | 25 | 52x62x3 | | 52x62x1 |





| |  |  |  |  |  |  |  |  |  |  |  | |
|---------------|---|---|---|---|---|---|---|---|---|---|---|--------------|
| A 50 2 | ø6x16 | 100x10 | 8x7x25 B | | 14x9x70 A | 22x14x49 C | RCK 19 ø75 | | T.C.E. M8x22 | T.C.E. M12x20 | ø13 | 75x100x10 DL |
| A 50 3 | ø6x16 | 100x10 | 8x7x25 B | 10x8x35 B | 14x9x70 A | 22x14x49 C | RCK 19 ø75 | T.E. M14x40 | T.C.E. M8x22 | T.C.E. M12x20 | ø13 | 75x100x10 DL |

Modulo uscita
Output sub-assembly
Abtriebseinheit
Module de sortie
Módulo de salida



| Pos. | Descrizione | Description | Benennung | Description | Descripción |
|------|--------------|--------------|-------------------|-----------------|----------------|
| 152 | Corona | Gear | Zahnrad | Couronne | Corona |
| 201 | Pignone | Pinion gear | Ritzel | Pignon | Piñon |
| 202 | Corona | Gear | Zahnrad | Couronne | Corona |
| 231 | Pignone | Pinion gear | Ritzel | Pignon | Piñon |
| 232 | Corona | Gear | Zahnrad | Couronne | Corona |
| 301 | Cassa | Housing | Gehäuse | Carter | Caja |
| 302 | Guarnizione | Gasket | Dichtung | Joint plat | Junta |
| 303 | Coperchio | Cover | Deckel | Couvercle | Tapa |
| 304 | Guarnizione | Gasket | Dichtung | Joint plat | Junta |
| 305 | Flangia | Flange | Flansch | Bride | Brida |
| 309 | Albero | Shaft | Welle | Arbre | Eje |
| 316 | Cappello | Holder | Deckel | Capuchon | Sombbrero |
| 851 | Albero lento | Output shaft | Abtriebswelle | Arbre de sortie | Eje de salida |
| 852 | Protezione | Safety cover | Schutzvorrichtung | Protection | Protección |
| 855 | Guarnizione | Gasket | Dichtung | Joint plat | Junta |
| 856 | Distanziale | Spacer ring | Distanzring | Entretoise | Distanciadador |



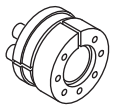

| |  | | | | | | |  | | |  | | |  | |  | |  |
|---------------|---|-------|--------|-------|-------|-------|-------|---|------|------|---|-----------|-----------|---|--------|---|--|---|
| | 5301 | 5302 | 5303 | 5304 | 5320 | 5321 | 5322 | 5251 | 5331 | 5330 | 853 | 5252 | 5332 | 5253 | 5852 | 5325 | | |
| A 60 2 | 31307 | 31308 | 32018X | 32216 | | | | | 80 | De30 | 90x110x3.5 R | | 68x80x3 R | 80x8 | 110x10 | ø6x16 | | |
| A 60 3 | | | 32018X | 32216 | 32208 | 33205 | 32208 | 80 | 80 | De30 | 90x110x3.5 R | 68x80x3 R | 68x80x1 R | 80x8 | 110x10 | ø6x16 | | |

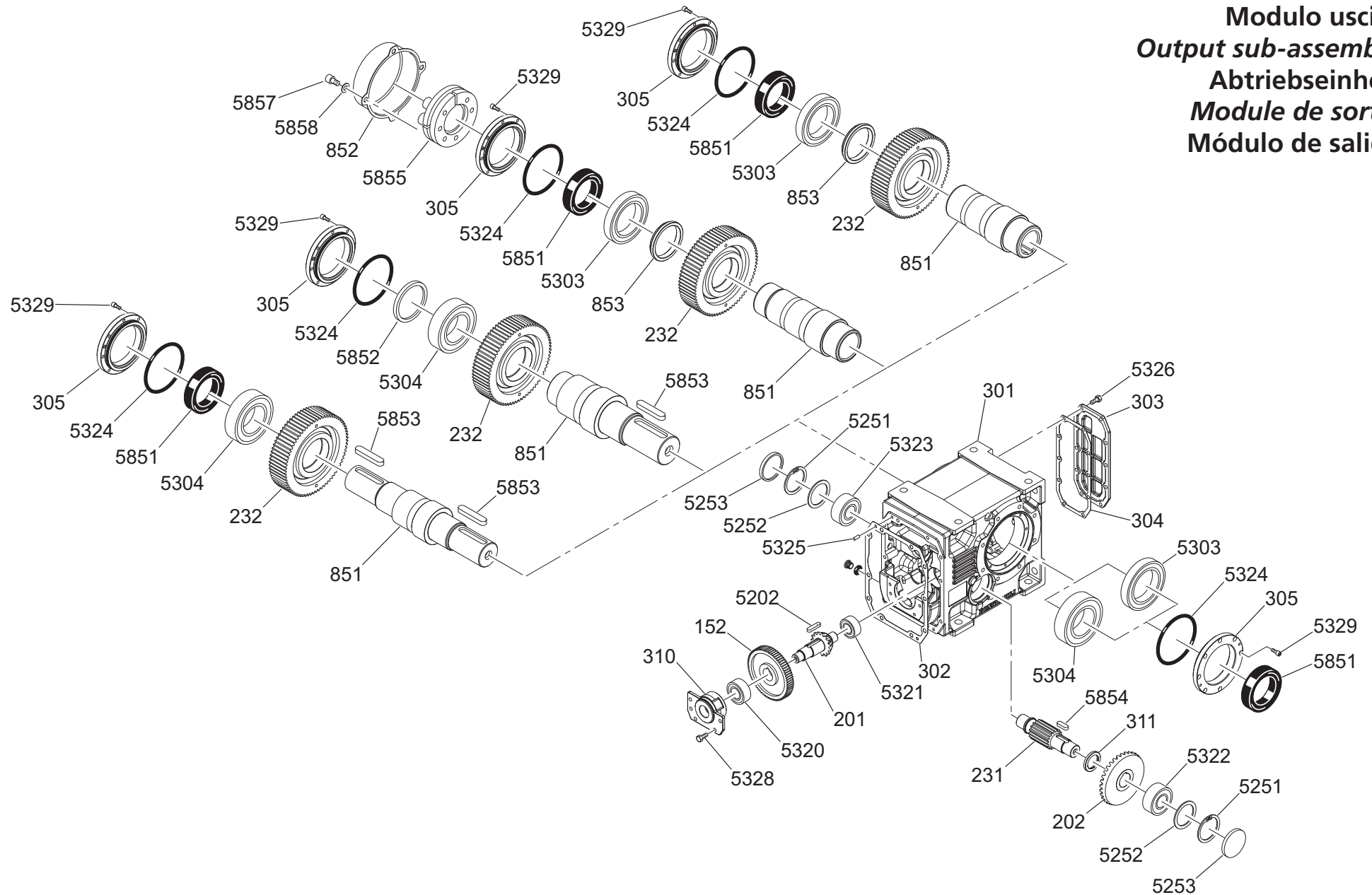



| |  | | | |  | | | |  |  | OR | |  |
|---------------|---|-----------|------------|------------|---|------------|--------------|---------------|---|---|------------|-------------|---|
| | 5202 | 5334 | 5853 | 5854 | 5326 | 5327 | 5329 | 5857 | 5858 | 5851 | 5254 | 5324 | 5855 |
| A 60 2 | 8x7x30 B | | 18x11x90 A | 25x14x60 B | T.E. M8x25 | T.E. M8x25 | T.C.E. M8x22 | T.C.E. M12x20 | ø13 | 90x110x12 DL 80x110x10 DL | 75.87x2.62 | 133.02x2.62 | CAL.19 D90 VTCEI 12 |
| A 60 3 | 8x7x30 B | 12x8x28 C | 18x11x90 A | 25x14x60 B | T.E. Mx25 | T.E. M8x25 | T.C.E. M8x22 | T.C.E. M12x20 | ø13 | 90x110x12 DL 80x110x10 DL | 75.87x2.62 | 133.02x2.62 | CAL.19 D90 VTCEI 12 |

Modulo uscita
Output sub-assembly
Abtriebseinheit
Module de sortie
Módulo de salida

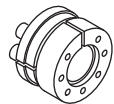

| Pos. | Descrizione | Description | Benennung | Description | Descripción |
|------|-------------------------|-----------------|-------------------|-------------------|-------------------------|
| 152 | Corona | Gear | Zahnrad | Couronne | Corona |
| 201 | Pignone | Pinion gear | Ritzel | Pignon | Piñon |
| 202 | Corona | Gear | Zahnrad | Couronne | Corona |
| 231 | Pignone | Pinion gear | Ritzel | Pignon | Piñon |
| 232 | Corona | Gear | Zahnrad | Couronne | Corona |
| 301 | Cassa | Housing | Gehäuse | Carter | Caja |
| 302 | Guarnizione | Gasket | Dichtung | Joint plat | Junta |
| 303 | Coperchio | Cover | Deckel | Couvercle | Tapa |
| 304 | Guarnizione | Gasket | Dichtung | Joint plat | Junta |
| 305 | Cappello | Holder | Deckel | Capuchon | Sombrero |
| 310 | Supporto per cuscinetto | Bearing support | Lageraufnahme | Support roulement | Soporte para rodamiento |
| 311 | Distanziale | Spacer ring | Distanzring | Entretoise | Distanciador |
| 851 | Albero lento | Output shaft | Abtriebswelle | Arbre de sortie | Eje de salida |
| 852 | Protezione | Safety cover | Schutzvorrichtung | Protection | Protección |
| 853 | Distanziale | Spacer ring | Distanzring | Entretoise | Distanciador |
| 931 | Flangia | Flange | Flansch | Bride | Brida |





| |  | | |  |  |  |  |  | | | | |
|------|---|-------|-------|---|---|---|---|---|-------|--------|---------|-----------------|
| | 5303 | 5304 | 5320 | 5321 | 5322 | 5323 | 5251 | 5252 | 5325 | 5253 | 5852 | 5855 |
| A 70 | 6021 | 32218 | 33207 | 33206 | 32308 B | 32308 | 90 | 70x90x3.5 | ø8x20 | ø90x10 | ø130x12 | TLK 600.03 ø100 |

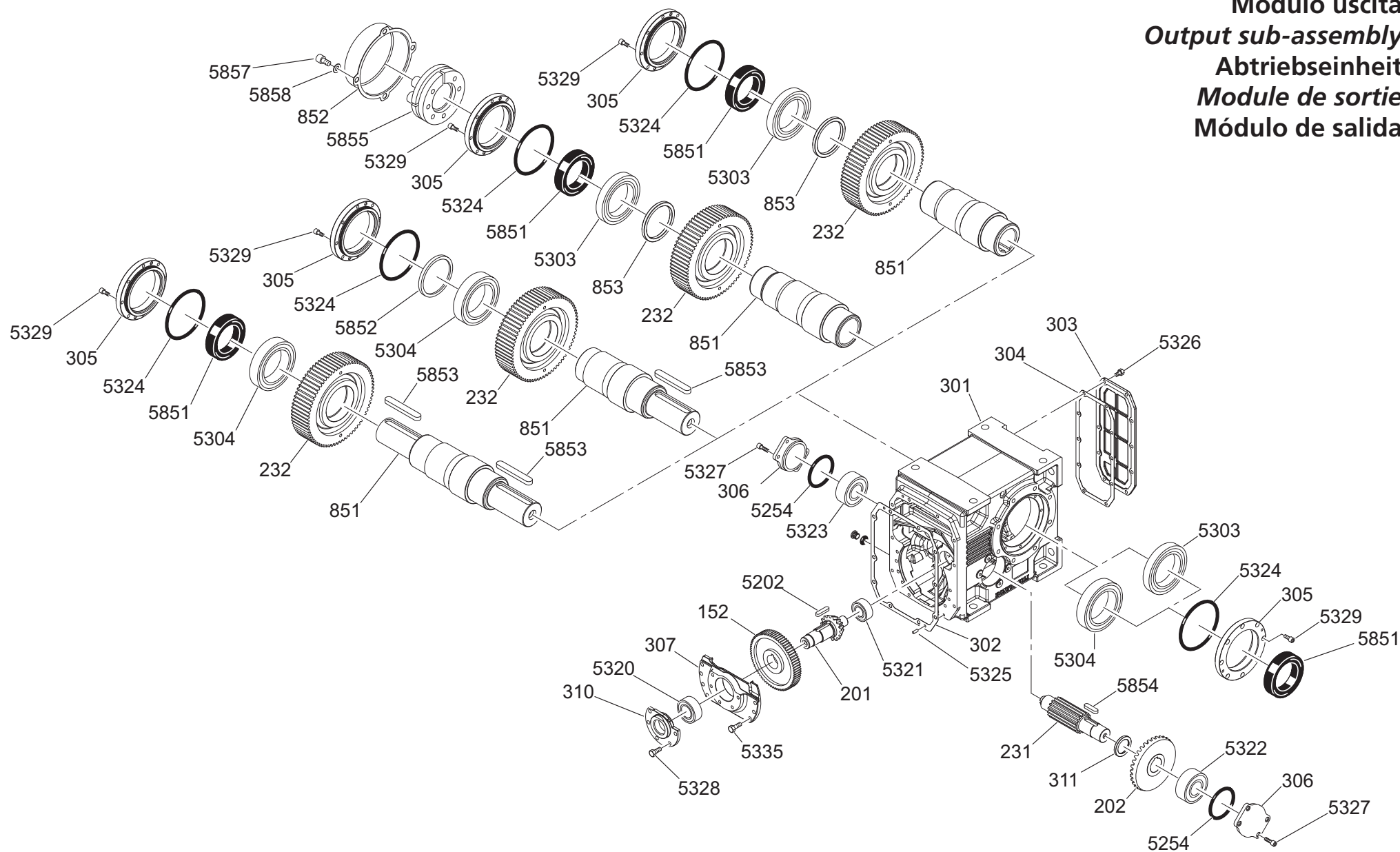



| |  | | |  |  |  |  | | | |
|------|---|---------------|-------------|---|---|---|---|------|-----------------------------------|------------|
| | 5202 | 5853 | 5854 | 5326 | 5328 | 5329 | 5857 | 5858 | 5851 | OR 5324 |
| A 70 | 12x8x45 "C" | 22x14x110 "A" | 14x9x41 "C" | T.E. M10x25 | T.E. M10x25 | T.C.E. M8x22 | T.C.E. M14x25 | ø15 | 105x130x12 "DL" 90x130x12 "DL" | 4600 |

Modulo uscita
Output sub-assembly
Abtriebseinheit
Module de sortie
Módulo de salida

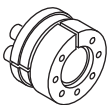

| Pos. | Descrizione | Description | Benennung | Description | Descripción |
|------|-------------------------|-----------------|-------------------|-------------------|-------------------------|
| 152 | Corona | Gear | Zahnrad | Couronne | Corona |
| 201 | Pignone | Pinion gear | Ritzel | Pignon | Piñon |
| 202 | Corona | Gear | Zahnrad | Couronne | Corona |
| 231 | Pignone | Pinion gear | Ritzel | Pignon | Piñon |
| 232 | Corona | Gear | Zahnrad | Couronne | Corona |
| 301 | Cassa | Housing | Gehäuse | Carter | Caja |
| 302 | Guarnizione | Gasket | Dichtung | Joint plat | Junta |
| 303 | Coperchio | Cover | Deckel | Couvercle | Tapa |
| 304 | Guarnizione | Gasket | Dichtung | Joint plat | Junta |
| 305 | Cappello | Holder | Deckel | Capuchon | Sombrero |
| 306 | Cappello | Holder | Deckel | Capuchon | Sombrero |
| 307 | Supporto per cuscinetto | Bearing support | Lageraufnahme | Support roulement | Soporte para rodamiento |
| 310 | Supporto per cuscinetto | Bearing support | Lageraufnahme | Support roulement | Soporte para rodamiento |
| 311 | Distanziale | Spacer ring | Distanzring | Entretoise | Distanciador |
| 851 | Albero lento | Output shaft | Abtriebswelle | Arbre de sortie | Eje de salida |
| 852 | Protezione | Safety cover | Schutzvorrichtung | Protection | Protección |
| 853 | Distanziale | Spacer ring | Distanzring | Entretoise | Distanciador |

| |  | | | | | |  |  |  | | |
|------|---|-------|-------|-------|---------|-------|---|---|---|---------------|--------------|
| | 5303 | 5304 | 5320 | 5321 | 5322 | 5323 | 5325 | 5852 | 5202 | 5853 | 5854 |
| A 80 | 6024 | 32024 | 33209 | 33207 | 32310 B | 32310 | ø8x20 | ø150x12 | 14x9x57 "C" | 25x14x160 "A" | 16x10x50 "C" |
| A 90 | 6026 | 32026 | 32310 | 32309 | 32312 B | 32312 | ø12x30 | ø170x12 | 18x11x82 "C" | 28x16x190 "A" | 18x11x60 "C" |

| |  |  | | | | | |  |  |  | |
|------|---|---|-----------------|-------------|---------------|-------------|---------------|---|---|---|------|
| | 5855 | 5326 | 5327 | 5328 | 5329 | 5335 | 5857 | 5858 | 5851 | 5254 | 5324 |
| A 80 | TLK 600.03 ø110 | T.E. M10x25 | T.C.E.I. M10x25 | T.E. M12x30 | T.C.E. M10x25 | T.E. M12x35 | T.C.E. M16x30 | ø17 | 120x150x12 "DL" | 4412 | 4675 |
| A 90 | TLK 600.03 ø125 | T.E. M10x25 | T.C.E.I. M10x25 | T.E. M16x30 | T.C.E. M10x30 | T.E. M16x40 | T.E. M20x30 | ø21 | 130x170x12 "DL" | 4487 | 4750 |

A 20 3

A 30 3

A 41 3





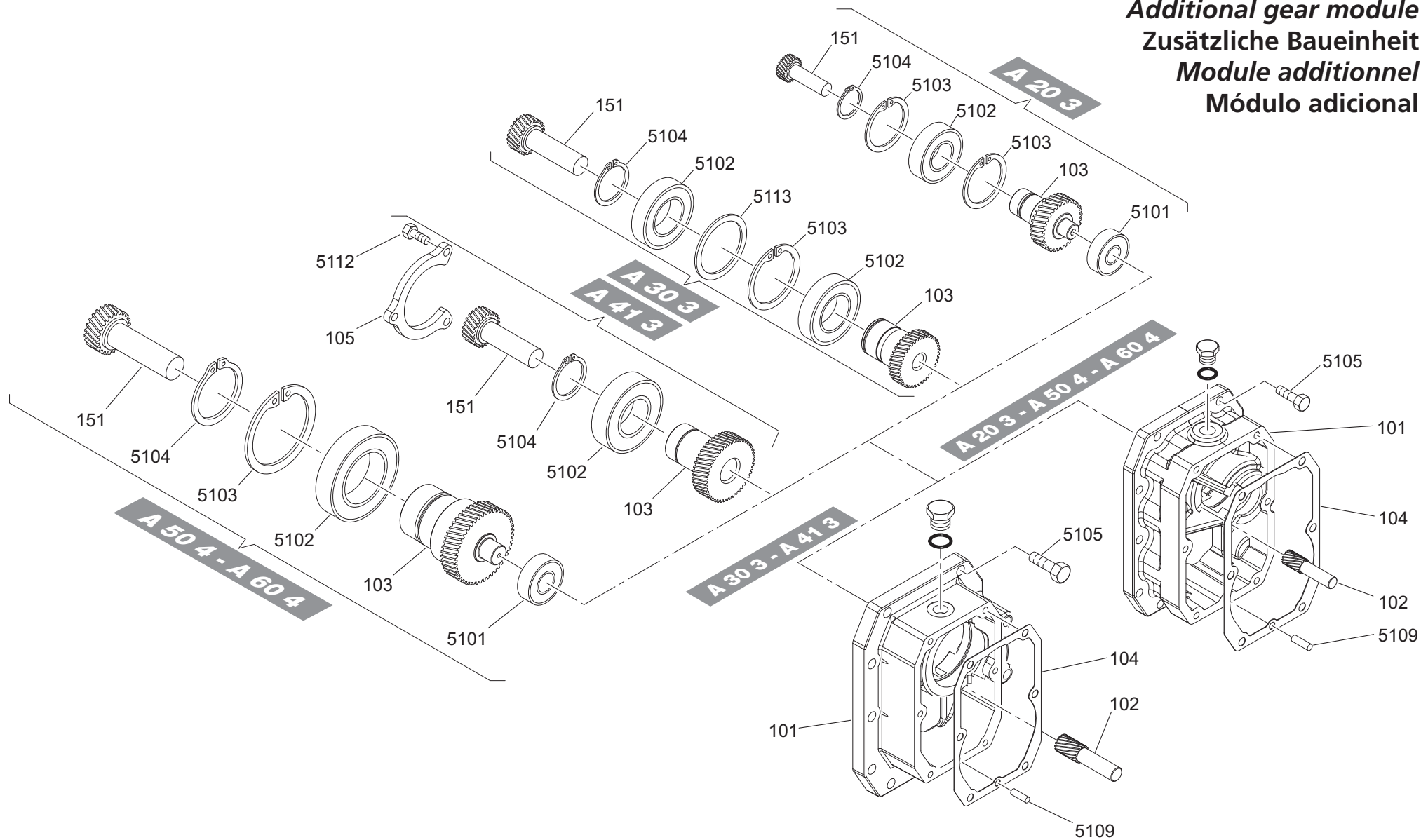

A 50 4

A 60 4

Modulo addizionale
Additional gear module
Zusätzliche Baueinheit
Module additionnel
Módulo adicional



| Pos. | Descrizione | Description | Benennung | Description | Descripción |
|------|----------------------------------|------------------------|------------------------|--------------------|--------------------------------|
| 101 | Modulo addizionale | Additional gear module | Zusätzliche Baueinheit | Module additionnel | Módulo adicional |
| 102 | Pignone | Pinion gear | Ritzel | Pignon | Piñon |
| 103 | Corona | Gear | Zahnrad | Couronne | Corona |
| 104 | Guarnizione | Gasket | Dichtung | Jointplat | Junta |
| 105 | Anello di battuta per cuscinetto | Bearing retainer | Schlußring | Bague de fermeture | Anillo de tope para rodamiento |
| 151 | Pignone | Pinion gear | Ritzel | Pignon | Piñon |

| |  |  |  |  |  |  | | |
|---------------|--|---|--|---|---|---|------------|-------------|
| | 5101 | 5102 | 5104 | 5103 | 5109 | 5105 | 5112 | 5113 |
| A 20 3 | 6201 2Z | 6004 | 20 | 42 | 5x16 | T.C.E. M6x20 T.C.E. M6x50 | | |
| A 30 3 | | 6006 | 30 | 55 | 5x16 | T.C.E. M8x25 T.C.E. M8x60 | | 45x55x2 "R" |
| A 41 3 | | 3206-2RS | 30 | | 5x16 | T.E. M8x25 T.E. M8x65 | T.E. M6x16 | |
| A 50 4 | NJ202 | 6008 | 40 | 68 | 6x16 | T.E. M10x35 T.E. M10x75 | | |
| A 60 4 | NJ203 | 6010 | 50 | 80 | 6x16 | T.E. M10x35 T.E. M10x80 | | |

A 70





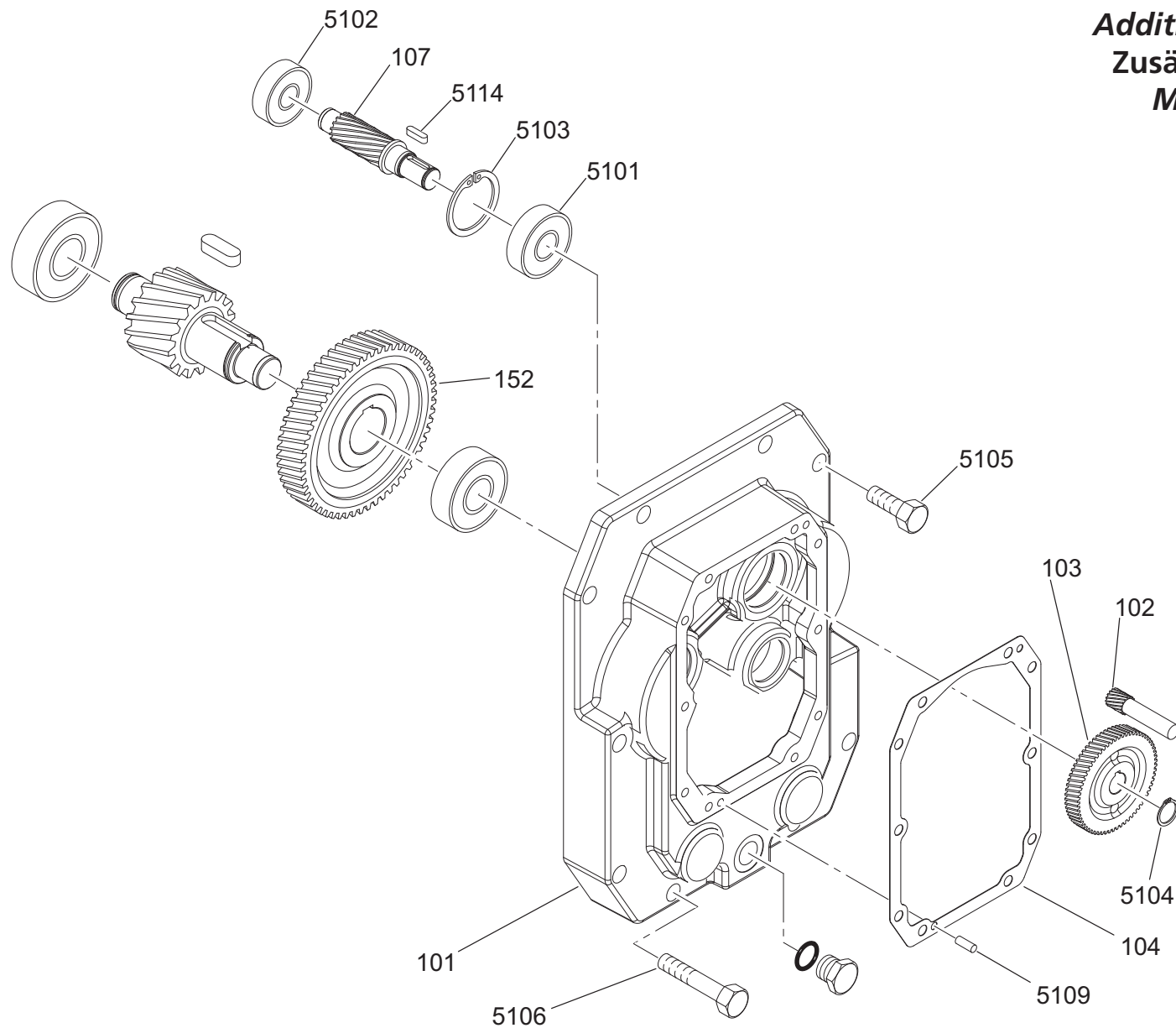

A 80

A 90

Modulo addizionale
Additional gear module
Zusätzliche Baueinheit
Module additionnel
Módulo adicional



| Pos. | Descrizione | Description | Benennung | Description | Descripción |
|------|-------------------------|------------------------|------------------------|--------------------|-------------------------|
| 101 | Modulo addizionale | Additional gear module | Zusätzliche Baueinheit | Module additionnel | Módulo adicional |
| 102 | Pignone | Pinion gear | Ritzel | Pignon | Piñon |
| 103 | Corona | Gear | Zahnrad | Couronne | Corona |
| 104 | Guarnizione | Gasket | Dichtung | Jointplat | Junta |
| 107 | Pignone | Pinion gear | Ritzel | Pignon | Piñon |
| 106 | Supporto per cuscinetto | Bearing support | Lageraufnahme | Support roulement | Soporte para rodamiento |
| 411 | Corona | Gear | Zahnrad | Couronne | Corona |



| |  |  |  |  |  |  | | | | |
|------|---|---|---|---|---|---|------|------|------|-------|
| | 5101 | 5102 | 5114 | 5105 | 5106 | 5115 | 5104 | 5103 | 5109 | 51156 |
| A 70 | 6304 | 6303 | 5x5x19 C | T.E. M12x35 | T.E. M12x65 | T.C.E.I. M12x30 T.C.E.I. M12x40 | 17 | 52 | 6x16 | 8x26 |
| A 80 | 6404 | 6304 | 6x6x25 C | T.E. M12x35 | T.E. M12x65 | T.C.E.I. M12x30 | 20 | 72 | 6x16 | 8x30 |
| A 90 | 6306 | 6305 | 8x7x25 C | T.E. M16x50 | T.E. M16x80 | T.C.E.I. M16x35 | 25 | 72 | 6x16 | |

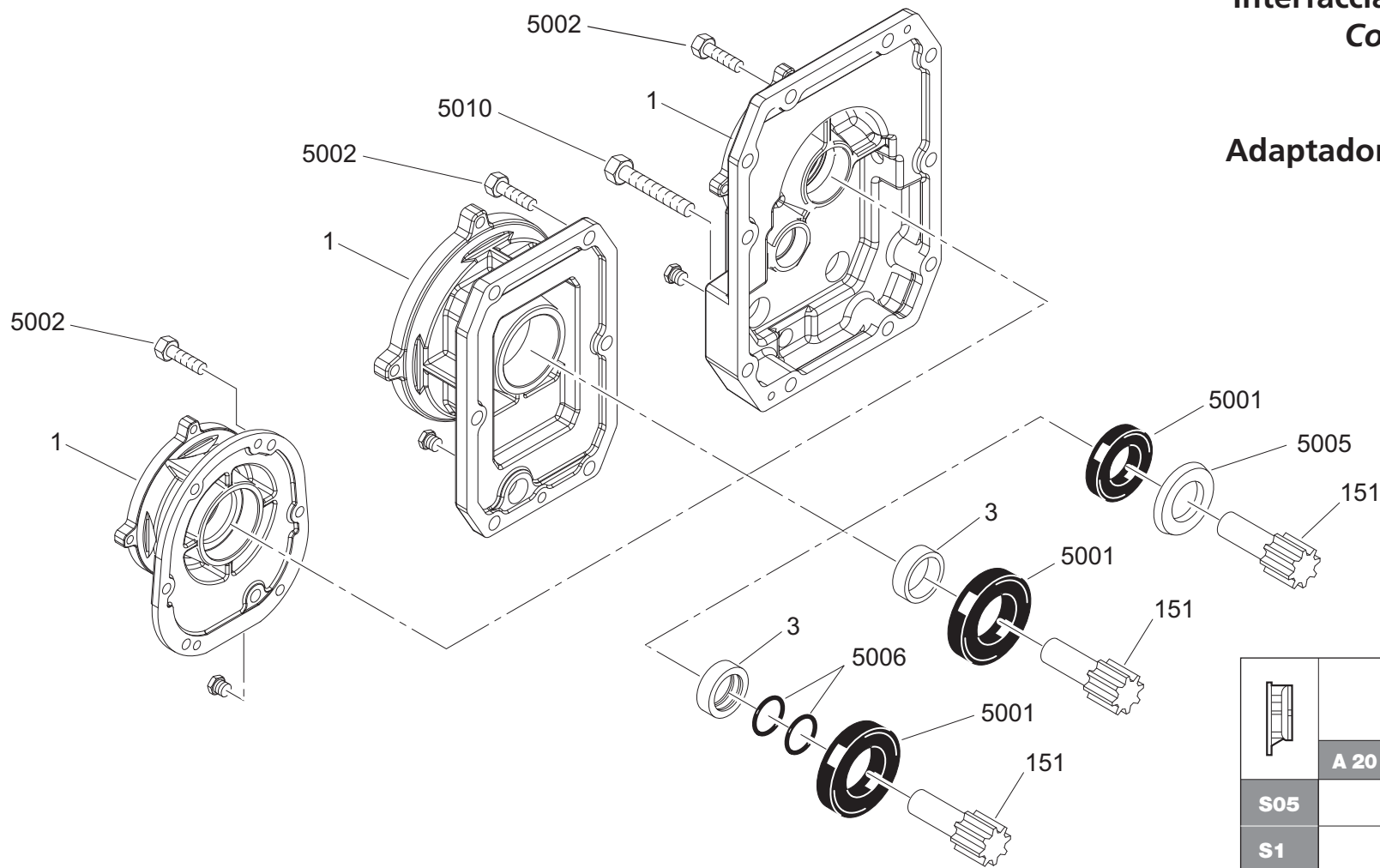

Interfaccia per motore compatto
Compact motor interface
S Baueinheit
Module S
Adaptador para motor compacto



| | OR 5006 | | |
|------------|-------------|-------------|---------------|
| | A 20 - A 30 | A 41 - A 50 | A 60 ... A 90 |
| S05 | | | |
| S1 | | | |
| S2 | | | |
| S3 | 4137 | 4137 | 4137 |
| S4 | | 149 | 149 |
| S5 | | | 149 |

| Pos. | Descrizione | Description | Benennung | Description | Descripción |
|------|-------------|-------------|-----------|-------------|-------------|
| 1 | Coperchio | Cover | Deckel | Couvercle | Tapa |
| 3 | Boccola | Bushing | Buchse | Douille | Casquillo |
| 151 | Pignone | Pinion gear | Ritzel | Pignon | Piñon |



|  |  5001 | | | | | |  5005 | | | | |
|---|---|------------------------|------------------------|--------------------------|--------------------------|--------------------------|---|-----------|-------------|-------------|-------------|
| | A 10 | A 20 | A 30 | A 41 - A 50 | A 60 - A 70 | A 80 - A 90 | A 10 - A 20 | A 30 | A 41 - A 50 | A 60 - A 70 | A 80 - A 90 |
| S05 | 20x35x7 L | 20x35x7 L | | | | | 20x35x4 | | | | |
| S1 | 20x35x7 L 25x35x7 L | 20x35x7 L 25x35x7 L | 20x35x7 L 25x35x7 L | 20x35x7 L 25x35x7 L | | | 20x35x4 | 20x35x4 | 20x35x4 | | |
| S2 | 35x55x8 L | 35x55x8 L 42x55x8 L | 35x55x8 L 42x55x8 L | 35x55x8 L 42x55x8 L | 35x55x8 L 42x55x8 L | | 35x52x4.5 | 35x52x4.5 | 35x52x4.5 | 35x52x4.5 | |
| S3 | 35x62x7 L | 35x62x7 L 48x62x8 L | 35x62x7 L 48x62x8 L | 35x62x7 L 48x62x8 L | 35x62x7 L 48x62x8 L | 35x62x7 L 48x62x8 L | 35x52x4.5 | 35x52x4.5 | 35x52x4.5 | 35x52x4.5 | 35x52x4.5 |
| S4 | | | | 45x85x10 L 65x85x10 L | 45x85x10 L 65x85x10 L | 45x85x10 L 65x85x10 L | | | 45x62x4.5 | 45x62x4.5 | 45x62x4.5 |
| S5 | | | | | 45x85x10 L 65x85x10 L | 45x85x10 L 65x85x10 L | | | | 45x62x4.5 | 45x62x4.5 |



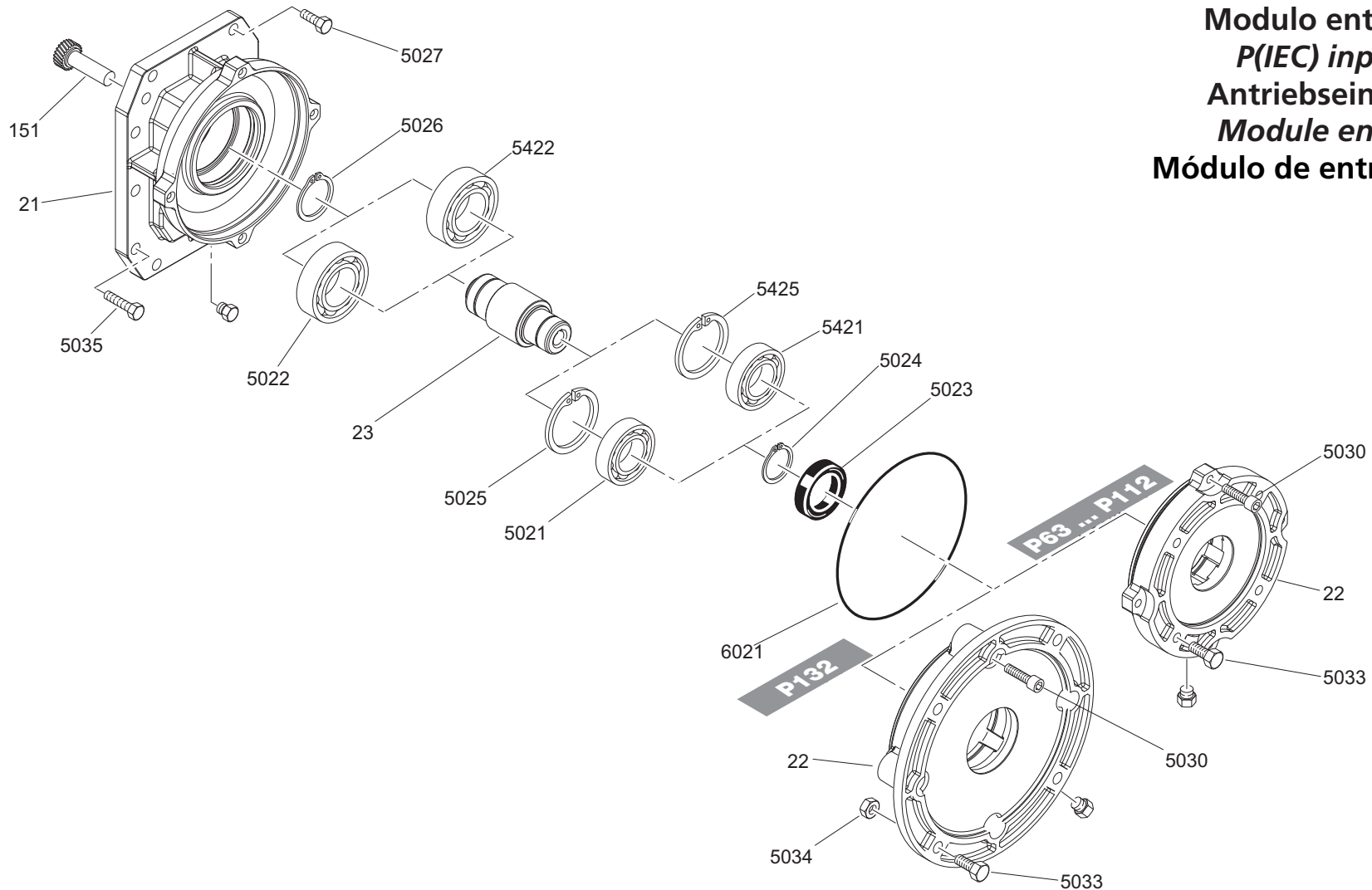

|  |  5002 | | | | | | | | |  5010 | | |
|---|---|----------------------------------|-------|----------------|------------------|--------|--------|--------|--------|---|--------|--------|
| | A 10 | A 20 | A 30 | A 41 | A 50 | A 60 | A 70 | A 80 | A 90 | A 70 | A 80 | A 90 |
| S05 | M6x18 M6x20 M6x22 | M6x20 | | | | | | | | | | |
| S1 | M6x20 M6x22 | M6x16 M6x18 M6x20 M6x22 | M8x25 | M8x25 | M10x25 M10x30 | | | | | | | |
| S2 | M6x20 M6x22 | M6x20 M6x22 | M8x25 | M8x20 M8x25 | M10x25 M10x30 | M10x30 | M12x35 | | | M12x65 | | |
| S3 | M6x20 M6x22 | M6x20 M6x22 | M8x25 | M8x20 M8x25 | M10x25 M10x30 | M10x30 | M12x35 | M12x35 | M16x50 | M12x65 | M12x65 | M16x80 |
| S4 | | | | M8x20 M8x25 | M10x25 M10x30 | M10x30 | M12x35 | M12x35 | M16x50 | M12x65 | M12x65 | M16x80 |
| S5 | | | | | | M10x30 | M12x35 | M12x35 | M16x50 | M12x65 | M12x65 | M12x80 |

**Modulo entrata P(IEC)
 P(IEC) input module
 Antriebseinheit P(IEC)
 Module entree P(IEC)
 Módulo de entrada P(IEC)**



| Pos. | Descrizione | Description | Benennung | Description | Descripción |
|------|---------------|-------------|---------------|--------------|----------------|
| 21 | Coperchio | Cover | Deckel | Couvercle | Tapa |
| 22 | Flangia | Flange | Flansch | Bride | Brida |
| 23 | Albero veloce | Input shaft | Antriebswelle | Arbre rapide | Eje de entrada |
| 151 | Pignone | Pinion gear | Ritzel | Pignon | Piñon |







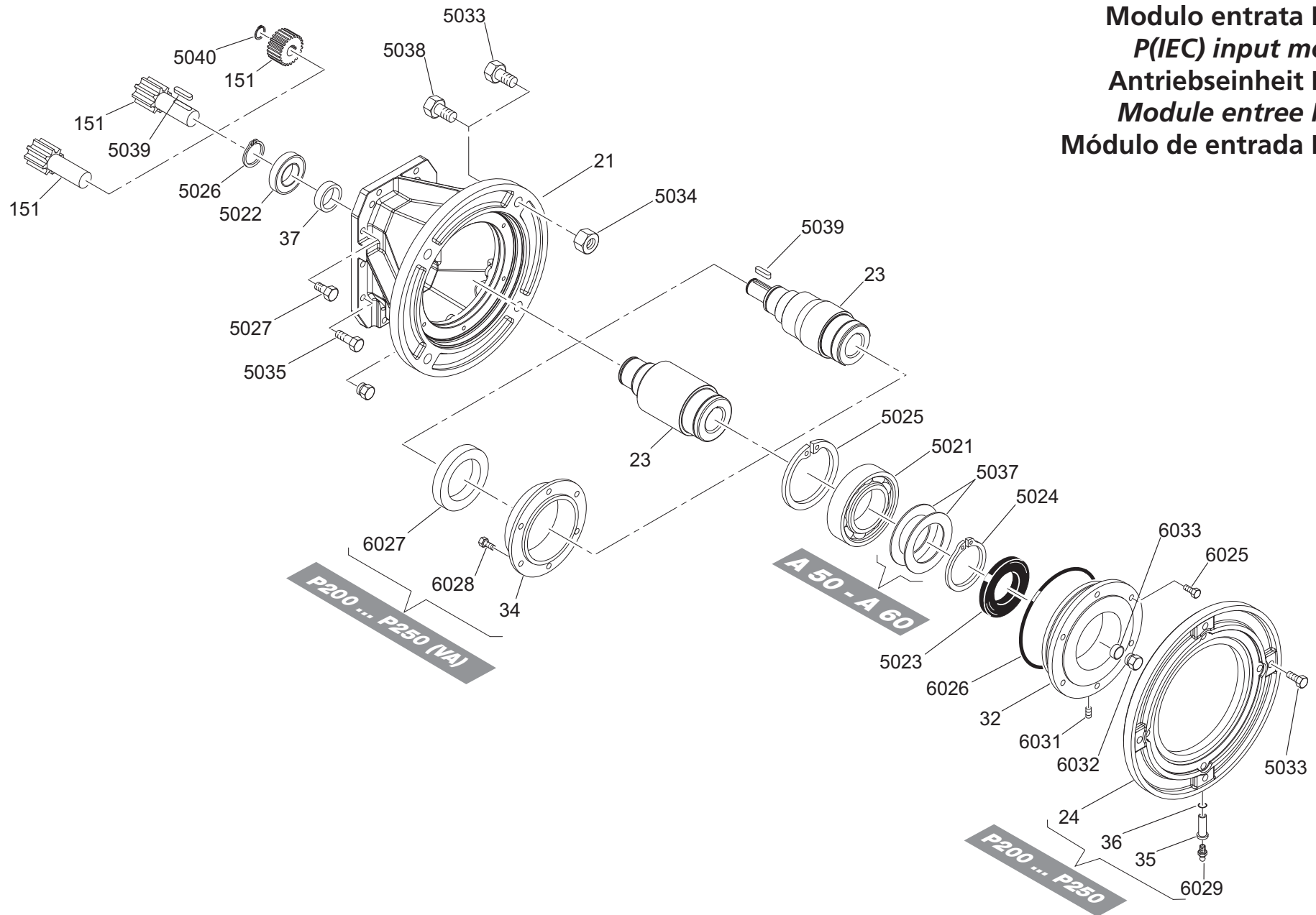



| |  | | | | | | | | | |  | | | | |  | | |
|----------------------------|---|----------------|-------|----------------|------------------|--------|--------|--------|--------|-------|---|--------|--------|--------|---------------|---|---------------|------|
| | 5027 | | | | | | | | | | 5030 | 5033 | 5035 | | | OR 6021 | | 5034 |
| | A 10 | A 20 | A 30 | A 41 | A 50 | A 60 | A 70 | A 80 | A 90 | | | A 70 | A 80 | A 90 | A 10 ... A 30 | A 41 ... A 90 | A 41 ... A 90 | |
| P63 | M6x20 | M6x20 M6x22 | M8x25 | M8x20 M8x25 | M10x25 M10x30 | M10x30 | M12x35 | | | M5x20 | M8x20 | M12x65 | | | 3475 | 3475 | | |
| P71 | M6x20 M6x22 | M6x20 M6x22 | M8x25 | M8x20 M8x25 | M10x25 M10x30 | M10x30 | M12x35 | | | M5x20 | M8x20 | M12x65 | | | 3475 | 3475 | | |
| P80 | M6x20 M6x22 | M6x20 M6x22 | M8x25 | M8x20 M8x25 | M10x25 M10x30 | M10x30 | M12x35 | M12x35 | M16x50 | M6x25 | M10x22 | M12x65 | M12x65 | M16x85 | 3575 | 3575 | | |
| P90 | M6x20 M6x22 | M6x20 M6x22 | M8x25 | M8x20 M8x25 | M10x25 M10x30 | M10x30 | M12x35 | M12x35 | M16x50 | M6x25 | M10x22 | M12x65 | M12x65 | M16x85 | 3575 | 3575 | | |
| P100 P112 | M6x20 M6x22 | M6x20 M6x22 | M8x25 | M8x20 M8x25 | M10x25 M10x30 | M10x30 | M12x35 | M12x35 | M16x50 | M6x30 | M12x30 | M12x65 | M12x65 | M16x85 | 3575 | 3800 | | |
| P132 | | | | M8x20 M8x25 | M10x25 M10x30 | M10x30 | M12x35 | M12x35 | M16x50 | M8x25 | M12x50 | M12x65 | M12x65 | M16x85 | | 3800 | M12 | |



| |  | |  | | | | | | | | | |  | |  | | | |
|----------------------------|---|-------------------------------------|--|---|-------------------|-------------------|-------------------|-------------------|-------------------|-------------------|-------------------|-------------------|---|------|---|------|---------------|------|
| | 5023 | 5021 | 5022 | | | | | | | | | | 5421 | 5422 | 5024 | 5026 | 5025 | 5425 |
| | | | A 10 | A 20 | A 30 | A 41 | A 50 | A 60 | A 70 | A 80 | A 90 | A 41 ... A 90 | | | | | A 41 ... A 90 | |
| P63 | 25x42x7 L | 6005-2RS 6005-2RS WT | 6006 | 6006 6006 2Z 6006-2RS WT | 6006 | 6006 | 6006 | 6006 | 6006 | | | | | 25 | 30 | 47 | | |
| P71 | 25x42x7 L | 6005-2RS 6005-2RS WT | 6006 | 6006 6006 2Z 6006-2RS WT | 6006 | 6006 | 6006 | 6006 | 6006 | | | | | 25 | 30 | 47 | | |
| P80 | 40x62x7 L | 6008-2RS 6008-2RS WT | 6007 6007 ETN9 | 6007 6007-2Z 6007-2RS WT 6007 ETN9 | 6007 6007 ETN9 | 6007 6007 ETN9 | 6007 6007 ETN9 | 6007 6007 ETN9 | 6007 6007 ETN9 | 6007 6007 ETN9 | 6007 6007 ETN9 | 6007 6007 ETN9 | | 40 | 35 | 68 | | |
| P90 | 40x62x7 L | 6008-2RS 6008-2RS WT | 6007 6007 ETN9 | 6007 6007-2Z 6007-2RS WT 6007 ETN9 | 6007 6007 ETN9 | 6007 6007 ETN9 | 6007 6007 ETN9 | 6007 6007 ETN9 | 6007 6007 ETN9 | 6007 6007 ETN9 | 6007 6007 ETN9 | 6007 6007 ETN9 | | 40 | 35 | 68 | | |
| P100 P112 | 45x72x8 L | 6009-2RS 6009-2RS WT 6012-2RS | 6007 ETN9 | 6007 ETN9 6007 6007-2Z 6007-2RS WT | 6007 ETN9 | 6209 | 6209 | 6209 | 6209 | 6209 | 6209 | 6209 | | 45 | 35 | 75 | | |
| P132 | 55x80x8 L | 6012-2RS WT | | | | 6209 | 6209 | 6209 | NJ209E | NJ209E | NJ209E | 6012-2RS | 6209 | 60 | 45 | 95 | 95 | |

**Modulo entrata P(IEC)
 P(IEC) input module
 Antriebseinheit P(IEC)
 Module entree P(IEC)
 Módulo de entrada P(IEC)**



| Pos. | Descrizione | Description | Benennung | Description | Descripción |
|------|-------------------------|----------------|---------------|--------------|--------------------------|
| 21 | Coperchio | Cover | Deckel | Couvercle | Tapa |
| 23 | Albero veloce | Input shaft | Antriebswelle | Arbre rapide | Eje de entrada |
| 32 | Cappello per cuscinetto | Bearing holder | Deckel | Capuchon | Sombrero para rodamiento |
| 37 | Distanziale | Spacer ring | Distanzring | Entretoise | Distanciador |
| 151 | Pignone | Pinion gear | Ritzel | Pignon | Piñon |







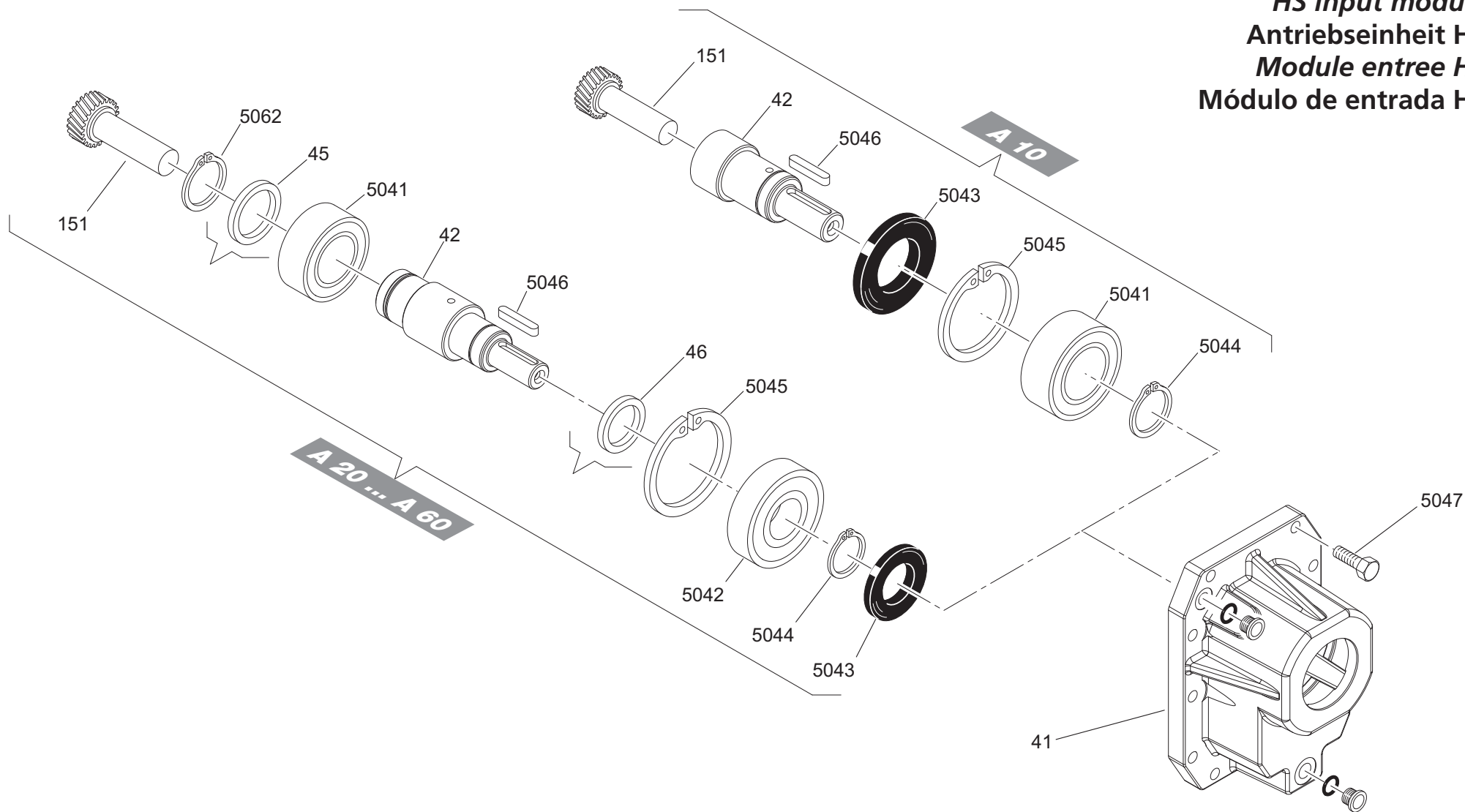

| |  | |  |  | | |  |  |  |  |  |  |  | | |
|----------------------|---|-----------------------------------|---|---|----------|----------|---|---|---|---|---|---|---|---------------|---------------|
| | 5021 | 5022 | 5039 | 5024 | 5026 | 5040 | 5025 | 5037 | 5034 | 6029 | 6031 | 6033 | 5023 | 6027 | |
| | | | | | | | | A 50 - A 60 | | A 80 - A 90 | A 80 - A 90 | A 80 - A 90 | A 50 - A 60 | A 70 ... A 90 | A 70 ... A 90 |
| P160 | 6016 6016 2RS 6216 6216 2RS | NUP210 6210 NUP310 6310 | 8x7x45 A | 80 | 50 | 30 | 125 140 | 80x100x2 P | M16 | | | | 80x110x10 L | 80x110x10 L | |
| P180 | 6016 6016 2RS 6216 6216 2RS | NUP210 NUP310 6310 6212 | 8x7x45 A 14x9x57 C | 80 | 50 60 | 30 48 | 125 140 | 80x100x2 P | M16 | | | | 80x110x10 L | 80x110x10 L | |
| P200 ... P250 | 6216 6216 2RS 3216 | 6310 NUP310 6212 NUP2212 | 8x7x45 A 14x9x57 C | 80 | 50 60 | 30 48 | 140 | | | M6 | M10x14 | 42x50x1.5 | | 80x110x10 L | 90x120x12 L |

| |  | | | | | | | | | | | |  | | |
|----------------------|---|--------|--------|--------|--------|-------------|---------------|---------------|-------------|---------------|---------------|-------------|---|---------------|--|
| | 5027 | | | | | 5033 | | | 5035 | 6025 | | 5038 | 6028 | 6026 | |
| | A 50 | A 60 | A 70 | A 80 | A 90 | A 50 - A 60 | A 70 ... A 90 | A 70 ... A 90 | A 50 - A 60 | A 70 ... A 90 | A 70 ... A 90 | A 80 - A 90 | A 50 - A 60 | A 70 ... A 90 | |
| P160 | M10x30 M10x35 M10x45 | M10x35 | M12x40 | M12x40 | M16x50 | M16x60 | M16x60 | M12x65 | M8x25 | M8x25 | | | 3725 | 3725 | |
| P180 | M10x30 M10x35 M10x45 | M10x35 | M12x40 | M12x40 | M16x50 | M16x60 | M16x60 | M12x65 | M8x25 | M8x25 | | | 3725 | 3725 | |
| P200 ... P250 | | | M12x40 | M12x40 | M16x50 | | M16x35 | M12x65 | | M8x25 | M16x40 | M6x16 | | 3725 | |

Modulo entrata HS
HS input module
Antriebseinheit HS
Module entree HS
Módulo de entrada HS





| Pos. | Descrizione | Description | Benennung | Description | Descripción |
|------|---------------|-------------|---------------|--------------|----------------|
| 41 | Coperchio | Cover | Deckel | Couvercle | Tapa |
| 42 | Albero veloce | Input shaft | Antriebswelle | Arbre rapide | Eje de entrada |
| 45 | Distanziale | Spacer ring | Distanzring | Entretoise | Distanciador |
| 46 | Distanziale | Spacer ring | Distanzring | Entretoise | Distanciador |
| 151 | Pignone | Pinion gear | Ritzel | Pignon | Piñon |

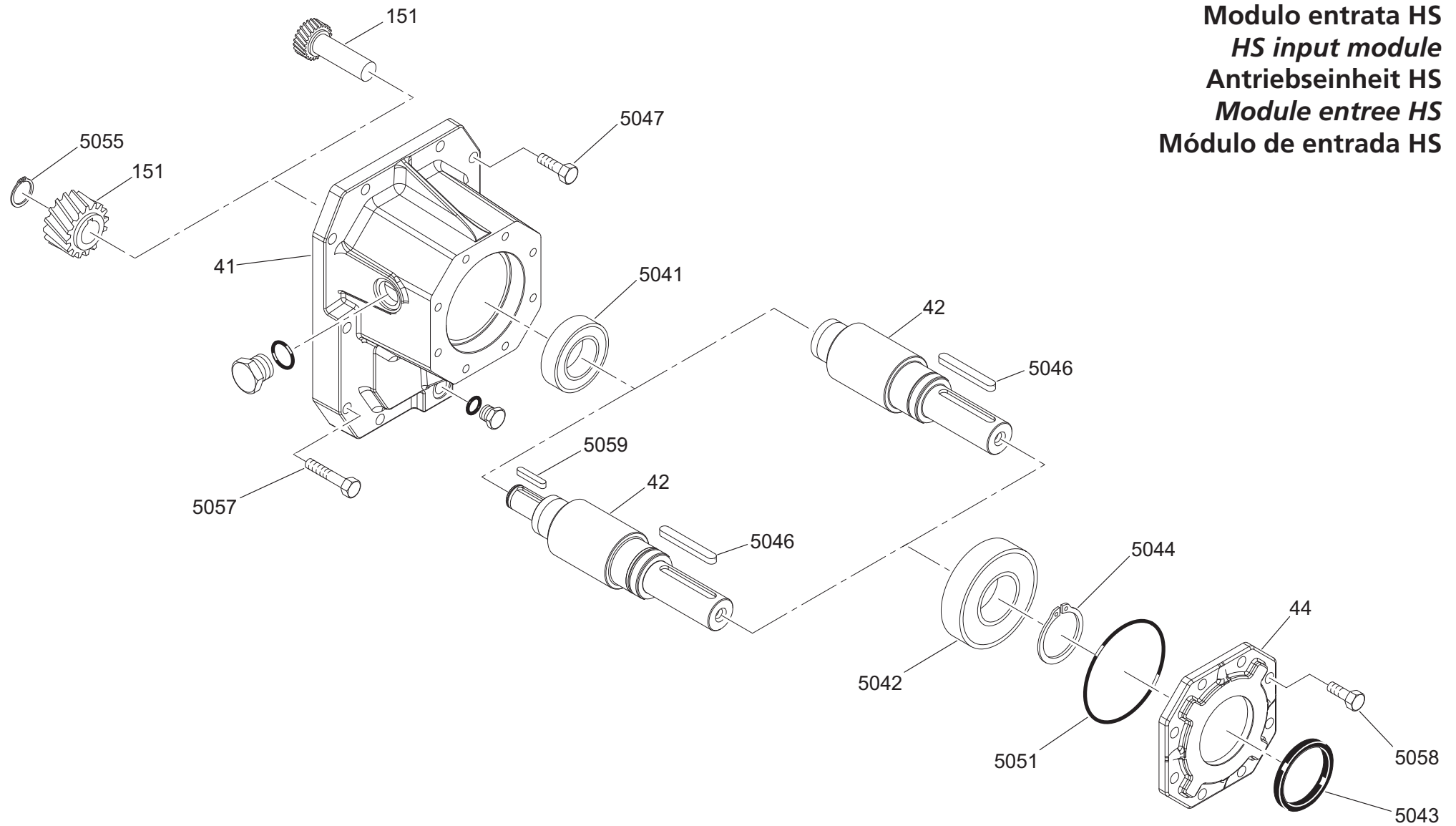

| |  |  |  |  |  |  |  |  |
|-------------|---|---|---|---|---|---|---|---|
| | 5041 | 5042 | 5043 | 5046 | 5044 | 5062 | 5045 | 5047 |
| A 10 | 3206-2RS | | 35x62x7 L | 5x5x35 A | 30 | | 62 | T.E. M6x20 T.E. M6x22 |
| A 20 | 6007 | 6206-2RS | 30x52x7 L | 6x6x35 A | 30 | 35 | 62 | T.E. M6x20 T.E. M6x22 |
| A 30 | 6207 | 6306-2RS | 30x52x7 L | 6x6x35 A | 30 | 35 | 72 | T.E. M8x25 T.E. M8x30 |
| A 41 | 6007 | 6206-2RS | 30x52x7 DL | 6x6x35 A | 30 | 35 | 62 | T.E. M8x25 T.E. M6x20 |
| A 50 | 6210 i = 18.9...21.1 NUP 210 i = 2.6...16.6 | 6308-2RS | 40x62x7 DL | 8x7x45 a | 40 | 50 | 90 | T.E. M10x35 |
| A 60 | 6310 | 6309-2RS | 45x72x8 DL | 8x7x50 A | 45 | 50 | 100 | T.E. M10x35 |

Modulo entrata HS
HS input module
Antriebseinheit HS
Module entree HS
Módulo de entrada HS

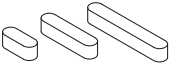

| Pos. | Descrizione | Description | Benennung | Description | Descripción |
|------|-------------------------|----------------|---------------|--------------|--------------------------|
| 41 | Coperchio | Cover | Deckel | Couvercle | Tapa |
| 42 | Albero veloce | Input shaft | Antriebswelle | Arbre rapide | Eje de entrada |
| 44 | Cappello per cuscinetto | Bearing holder | Deckel | Capuchon | Sombrero para rodamiento |
| 151 | Pignone | Pinion gear | Ritzel | Pignon | Piñon |

|  | | |  | |  | | | | | | |
|---|-----------------|---------|---|---------------------------------|---|---------------|-------------|-------------|----------|-----------------------|-----------|
| 5041 | | 5042 | | | 5043 | | 5046 | | 5059 | | |
| A 70 | A 80 | A 90 | A 70 - A 80 | A 90 | A 70 - A 80 | A 90 | A 70 - A 80 | A 90 | A 70 | A 80 | A 90 |
| NJ2210 | NJ310 NJ2212 | NJ2214E | 6312 6312-2RS 6312-2RS WT | 6320 6320-2RS 6320-2RS WT | 60x90x8 DL | 100x120x12 DL | 12x8x90 A | 18x11x120 A | 8x7x45 A | 8x7x45 A 14x9x57 C | 14x9x57 C |

|  | | | | |  | | | | | | |
|---|-----------|------|----------|------|---|--------|--------|--------|--------|-------------|--------|
| 5044 | | 5055 | | | 5047 | | 5057 | | | 5058 | |
| A 70 - A 80 | A 90 | A 70 | A 80 | A 90 | A 70 - A 80 | A 90 | A 70 | A 80 | A 90 | A 70 - A 80 | A 90 |
| 60 → 3 ← | 100 → 4 ← | 30 | 30 48 | 48 | M12x40 | M16x50 | M12x65 | M12x70 | M16x80 | M12x30 | M16x40 |

|  OR 5051 | |
|---|------|
| A 70 - A 80 | A 90 |
| 3500 | 3850 |

R0

| | Descrizione | Description | Benennung | Description | Descripción |
|--|-------------|-------------|-----------|-------------|-------------|
| | | | | | |

090420

Questa pubblicazione annulla e sostituisce ogni precedente edizione o revisione. Ci riserviamo il diritto di apportare modifiche senza preavviso. E' vietata la riproduzione anche parziale senza autorizzazione.

This publication cancels and replaces any previous edition and revision. We reserve the right to implement modifications without notice. This catalogue cannot be reproduced, even partially, without prior consent.

Diese Veröffentlichung annulliert und ersetzt jeder hergehende Edition oder Revision. BONFIGLIOLI behält sich das Recht vor, Änderungen ohne vorherige Informationen durchzuführen.

Cette publication annule et remplace toutes les autres précédentes. Nous nous réservons le droit d'apporter toutes modifications à nos produits. La reproduction et la publication partielle ou totale de ce catalogue est interdite sans a autorisation.

Esta publicación anula y sustituye toda anterior edición o revisión. Nos reservamos el derecho de aportar modificaciones sin previo aviso. Se prohíbe la reproducción incluso parcial sin autorización.